

Lair

Modern & Modular

Lair stations offer a variety of options and capabilities best used for space division and multiple work surfaces. This versatile product's options include benching, L-shapes, U-shapes, glass divider panels, confab seat cushions, tall hutches, & lower hutches.

Lair is the industry's most modestly priced version of new style modular workstations. It is solidly constructed with metal legs and sturdy stretchers.

Modular



*Can be electrified with ECA Electrical.



Multi-Layer Station \$2380 as shown

Lair 6'x6' station with multiple "Layers" of storage.



Flush Height in Tiger Stripe \$2903 as shown

Lair Flush Height Station with Personal Storage Tower. 6'x7'6" overall size. Includes 71x24 Top with 47x24 Return.

Lair

Benching Options



120 Degree Workstation

\$5160 as shown

120 degree stations in "Dog-Bone" configuration for six work stations. Only \$860 List Price per person. Includes 12" Frosted Glass Divider Panels shown. Approximate overall size is 16' X 9'.

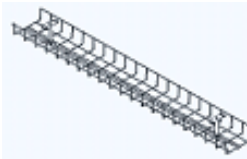

Lair Wire Management Basket

24" Wide L-WM-24, \$40
59" Wide L-WM-59, \$65

Pedestals are stocked in different colors, depths, and configurations - BBF, BF, FF, mobile, and more. BBF pedestals shown below.



White - W

Tiger Stripe - TS



Dark Walnut - DW

DW-W



Modern Walnut - MW

MW-W



NEW OP-2-Clamp \$80

2 Receptacles. Clamp mount for tables. 6' Cord.
UL Recognized

Lair Color Options:



Dark Walnut



Modern Walnut



Tiger Stripe

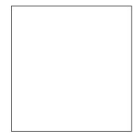

White



Lair Benching

\$3720 as shown

Lair Benching & Collaboration Center for 4 persons. Includes 4-71x30 work surfaces and 18" high Frosted Glass Divider Panels. Each work surface includes 2 grommets. Optional steel modesty panels include a wire management trough. Can be electrified.



Multi Lair

\$2955 as shown

Lair 6'x6' station with multiple "Layers" of storage and NEW Hutch with built in Paper Flow. Features NEW Single Sliding Door Hutch with built-in Paper Flow on Multi-Layer station and NEW Personal Storage Cabinet.

Modular

Lair

Modular



NEW

Station Top Color Choices:



Dark Walnut

Modern Walnut

Tiger Stripe

White

Lair T-Shape Desks

\$3096

Front/Back combination overhead. Tackboard can be custom upholstered in 6 Grade A colors for \$55 additional List per tackboard. Black tackboard shown.



Lair Kit - StandUP Table 40" High

71x30, \$640

71x24, \$585

66x30, \$635

66x24, \$590

48x24, \$540

36x24, \$510



Lair Double Corner Station

\$3316

Lair Double Corner Station with hutches. 12' x 7'



L-CAB-SS

\$300

Shelf/Shelf. Add \$90 for 36x24 Top # L-T3624

Top is required. Double wide top (71" Wide) L-T7124 \$135



Chassis Executive U

\$2936

Chassis Executive U with hutch and personal storage tower. Available in 4 two-tone colors. Overall size 8'6" x 7'6"

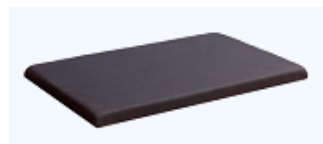

L-Seat36 BK

Optional padded confab seat.

Black \$170, Grade B \$225, Grade C \$245



L-CAB-BF

\$520

Box/File - Lateral. Add \$90 for 36x24 Top #L-3624

Top is required. Double wide top (71" wide) L-T7124 \$135

Lair and Chassis stations can include electrical system and wire management.

Lair

Perimeter

PERIMETER is a new and unique divider system that creates space division easily and very cost effectively. This new invention can mount at the



Perimeter of each station, or split down the middle of multiple stations. These beneficial panels do not take any space from one staff member at the expense of another. Perimeter has aluminum frames with **frosted acrylic inserts or custom upholstered fabric inserts**. Two heights are stocked at 12" and 24". Widths are 24" to 84". The product mounts to desk tops with Aluminum posts. Perimeter works with Lair, Chassis, EL Express Laminate, and EL Status Desks.

Reception counters, both straight and L shaped, attach to Perimeter and create reception stations. Our affordable desk products, plus Perimeter and ECA electrical, create full office "cubicles" without paying for expensive full-height panel systems.

Perimeter Panels

Panels in 12" and 24" in frosted or upholstered options

Modular



LAIR 2 STATIONS

\$3001

12' x 8'



LAIR RECEPTION STATION

\$2180

Multiple sizes and colors available



NEW

LAIR DOUBLE

\$3636

12' x 8' Double Station - 54" High







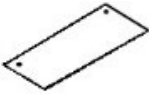

NEW

LAIR Curved Station

\$4101

Features NEW curved corner work space - 12' x 6' Double Station

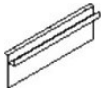
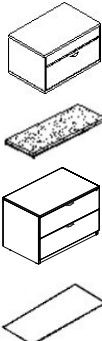
Model #	Image	Description	Color	List Price
Worksurfaces only - Legs and Stretcher required.				
L-T7130G L-T7124G L-T6630G L-T6624G L-T6024G L-T4824G L-T4224G L-T3624		71x30 w 2 Grommets 71x24 w 2 Grommets 66x30 w 2 Grommets 66x24 w 2 Grommets NEW 60x24 w 2 Grommets NEW 48x24 w1 Grommets 42x24 w 1 Grommets 36x24 NO Grommets	WT – White DW – Dark Walnut TS – Tiger Stripe MW – Modern Walnut NEW – Lair Tops are stocked in MW-Modern Walnut	\$150 \$135 \$145 \$140 \$110 \$100 \$95 \$90
L-T71/36/24G Left L-T71/36/24G Right NEW		71x36x24 Left top only for corner credenza 71x36x24 Right top only for corner credenza Requires 1-36" D Leg, 1-24"D Leg, 1 Top (L Or R) Plus a Bar71 Stretcher. \$600 Total	WT – White DW – Dark Walnut TS – Tiger Stripe MW – Modern Walnut	\$210 \$210
NEW L-T48 Half L-T60 Half L-LEGPOST-SQUARE L-Ubracket		48" Half round table end NO Leg - \$220 for Kit 60" Half round table end NO Leg - \$480 for Kit Lair Post Leg to support half round table end and Clear Leg. Order leg separately. 2 legs recommended for 60" size Pair of Brackets to mount T48 & T60 Half - Required	WT, DW, MW, TS WT, DW, MW, TS Leg = Silver	\$150 \$360 \$50 \$20
EL-Flat		2 Flat Brackets and 16 Screws REQUIRED for most returns and bridges	Black	\$8
Legs Desk Height				
L-Leg29H24DTall-S L-Leg29H30DTall-S L-LEG29H36DTall-S NEW		Lair Metal leg 24 Deep, Tall, Desk Height Lair Metal leg 30 Deep, Tall, Desk Height Lair Metal leg 36 Deep, Tall, Desk Height	Silver	\$130 \$150 \$165
L-LEG40H24D-S NEW L-LEG40H30D-S NEW		New Stand Up Height Below Lair Metal leg 24 Deep, 40" H, Stand-up HT. Lair Metal leg 30 Deep, 40" H, Stand-up HT.	Silver	\$165 \$185
Legs Short Height 8" High				
L-Leg8H30DLow-S L-Leg8H24DLow-S		Lair Metal leg 30 Deep, LOW Lair Metal Leg 24 Deep LOW	Silver	\$85 \$85
Stretcher—Anti Sag Required for ALL Tops with Legs Above				
L-Bar71-S L-Bar66-S L-Bar60-S L-Bar48-S L-Bar42-S L-Bar36-S L-Bar52-S HTBSTR50 HBSTR59		for 71" wide tops . for 66" wide tops. for 60" wide tops. for 48" wide tops. for 42" wide tops. for 36" wide tops. for Single Pedestal tops. 50" General Purpose Stretcher no fittings 59" General Purpose Stretcher no fittings	Silver	\$120 \$120 \$115 \$110 \$100 \$90 \$110 \$45 \$50
L-Mod-30-S L-Mod-48-S L-Mod-72-S L-Mod-72-SP		30" Modesty Panel 48" Modesty Panel 71" Modesty Panel Mod Panel for Single Ped 71"	Silver Includes wire management channel	\$100 \$130 \$195 \$195
Cabinets and Pedestals - Requires Top or Seat Cushion				
L-CAB-BF L-CAB-SS L-Seat36 BK L-Chas 1212-White L-T3624 L-T7124G		Low Cabinet 36W 24D 21H Box Drawer + Lateral Drawer Low Cabinet 36W 24D 21H 2 Open Shelf, No Drawers "CONFAB" Seat for Low Cabinet . Black Grade B \$310 Grade C \$410 2 Drawer Lateral full height with NO Top. Order top separately in 4 colors. 36" Top for Cabinets above. 71" Top for 2 Cabinets above.	WT – White DW – Dark Walnut Black Fabric White WT, DW, TS, MW	\$520 \$300 \$170 \$510 \$90 \$135



Now in More Colors: DW case w/White Drawer Fronts (DW-W) and MW (MW-W) MW Case w/White Drawer Fronts. TS All Over. (TS-TS) White All Over (W-W) - Also EL and Status Peds work with Lair. C, DW & MW.
NEW Optional Drawer Fronts ONLY L-566 and L575 \$30 List DW MW and TS. Requires assembly.

Model #	Image	Description	Color	
Box/Box/File 22" Deep L566 \$365	File/File 22" Deep L575 \$365	Box/Box/File 29" Deep L566-29 \$440	NEW Steel Mobile B/B/F # DT-Mobile Ped - Steel	
				\$345
L-PSC-54 DW/W L-PSC-54 W/W		Personal Storage Cabinet, 54HX24WX24D DW case with White Doors & Fronts. Personal Storage Cabinet, 54HX24WX24D All White	DW case with White Doors & fronts White case with White Doors & fronts	\$800 \$800
L-PSC-62-DW/W L-PSC-62-W/W		Personal Storage Tower 62HX 18WX24D DW case with White Doors & fronts Personal Storage Tower 62HX18WXX24D (All White)	DW case with White Doors & fronts White case with White Doors & fronts	\$700 \$700
Overhead Storage Cabinets/Hutches Sliding Doors are Optional				
L-H71 L-Bar71-S		71" Open Hutch w/o Doors, Anti-Sag Stiffener Required	WT – White DW – Dark Walnut MW – Modern	\$350 \$120
L-H71 Shared Hutch L-H71 Doors		Shared back to Back Hutch with black tackboard 4 Doors for 71" W Hutch	WT, MW Walnut WT-DW-MW-TS	\$350 \$120
L-Shelf71-WT L-H71-Bar-Shelf		Optional Shelf for H71 Hutch Stretcher bar for 71" wide Shelf , Required	WT – White Silver	\$120 \$65
Model #	Image	Description	Color	
Legs for Overhead Storage/Hutches				
L-HLegMid-S		Leg for Hutch Mid Height-Silver 19" High, used for standard Flush Height Stations. Makes 62"H Hutch	Silver	\$65
L-HLegLow-S		Leg for Hutch Low Height-Silver 10" High Makes 54" high Hutch – Low Hutch		\$45
L-HLegTall-S		Leg for Hutch Tall-Silver 27" High, used ONLY for Multi-Layer stations. Use 1 MID and 1 TALL for multi-layer application.		\$80
"Fancy" Hutch with 1 Sliding Door and Paper Flow				
L-HSD71DW/W L-HSDLeg-Mid-S L-HSDLeg-Tall-S L-Bar71-S		71" Hutch w one door and paper flow. 13.5 Leg Use 2 for Standard Height. 62" from Floor 22" Leg Use 1 each let Ht. for Multi-Layer station. Requires Stretcher Bar	WT Hutch + DW Door Silver	\$355 \$55 \$70 \$120
L-Bench-DW		Bench w File Storage 48x18x20H Padded & upholstered Black Fabric. Grade B \$825 Grade C \$900	CH – Cherry DW – Dark Walnut	\$620

LAIR Kits

Complete "KITS"

The drawing below shows TWO 3 person stations, with optional 12" H or 18" H Glass Divider Panels. Minimum order is 1 set of 3 stations, (half of a Dog Bone).

	QTY	Model	Leg Frame	List Each	Total List
	2	L-120-Leg-4848-S	Tops	\$1200	\$2400
	6	L-120-Top-4848-W	Divider Panels	\$300	\$1800
	6	ELD-GF1246	Panel Brackets	\$160	\$960
	12	ELD-B-Center Silver Approx. 16' X 9"		\$20	\$240
\$5,160 includes 12"H glass panels. Add \$120 for 18"H Divider Panels. Can be powered with ECA Electrical.					

The LAIR "Kits" below include a complete table or complete overhead

Item	KIT Model Number	Description	List
	Kit L-T7130 + 2 Legs + Bar	Table 71x30	WT – White DW – Dark Walnut MW – Modern Walnut TS – Tiger Stripe
	Kit L-T6630 + 2 Legs + Bar	Table 66x30	\$590
	Kit L-T7124 + 2 Legs + Bar	Table 71x24	\$565
	Kit L-T6624 + 2 Legs + Bar NEW	Table 66x24	\$515
	Kit L-T4824 + 2 Legs + Bar	Table 48x24	\$520
	Kit L-T4224 + 2 Legs + Bar	Table 42x24	\$470
	Kit L-T3624 + 2 Legs + Bar	Table 36x24	\$455
	Kit L-T71/36/24G Left	Table Corner 71x36x24	WT, DW, MW, TS
	Kit L-T71/36/24G Right Left is shown NEW		
	Kit L-T7130 + HILO Legs + Bar	Table 71x30	\$505
	Kit L-T6630 + HILO Legs + Bar	Table 66x30	\$500
	Kit L-T7124 + HILO Legs + Bar	Table 71x24	\$470
	Kit L-T7130 + Single Leg	Table 71x30	\$410
	Kit L-T6630 + Single Leg	Table 66x30	\$405
	Kit L-T7124 + Single Leg Kits above also include a single Ped stretcher	Table 71x24	\$375
	Kit L-T4824 + Single Leg	Table 48x24	\$340
	Kit L-T4224 + Single Leg	Table 42x24	\$335
	Kit L-T3624 + Single Leg	Table 36x24	\$330
	Kit L-H71 + Mid Legs + Bar 62" overall height	71" W Hutch	WT, DW, MW
	Kit L-H71 + Low Legs + Bar 54" overall height	71" W Hutch	\$600
	Kit L-H71 + HILO Legs + Bar 62" overall height, use with multi-layer stations	71" W Hutch	WT, DW, MW
	EL Flat	2 Flat brackets and 16 screws.	Required to connect main table to returns and bridges
			\$8

ASSEMBLY / SPECIFICATION HELP BELOW

Lair products are modular for maximum flexibility, but require specification of multiple components to make a complete product. Tables consist of a table top, a leg or legs and a stretcher bar for support. Line drawings of common configurations are shown below.

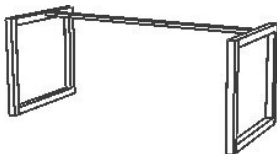

All worksurfaces must have a stretcher BAR for support. Legs are non-directional. Stretcher is in the middle of the leg and attaches to the leg with screws, provided.

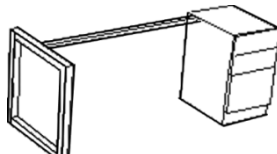

Single Ped Stretcher Bar (or Return)
Attaches to "O" Leg on Left and Screws to Top with self-taping screws. May need to be cut to fit with tops less than 71" wide.

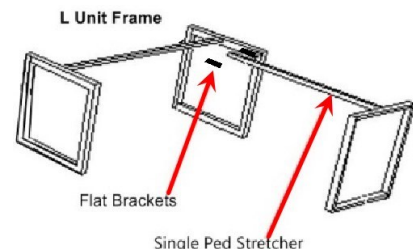

The end of a Lair table can be an "O" Leg (left) or a Pedestal (right) shown above.

Perimeter

PERIMETER has aluminum frames with **frosted acrylic inserts or custom upholstered fabric inserts**. Two heights are stocked at 12" and 24". Widths are 24" to 84". The product mounts to desk tops with Aluminum posts. Perimeter works with Lair, Chassis, Express Laminate, and Status Desks. Perimeter is shown below in its variety of lengths and heights.





Modular



EL Pinwheel with Multi-Height Panels



Chassis Multi-Height Panel Stations

12" High		12 & 24" High		24" High		12", 24" and 2-12" stacked		12" with transaction tops	
12" High Panels		Acrylic	A-Fabric	24" High Panels		Acrylic	A-Fabric		
ELAP-1224	12"H for 24"W surfaces	\$75	\$125	ELAP-2424	24"H for 24"W surfaces	\$100	\$175		
ELAP-1230	12"H for 30"W surfaces	\$90	\$140	ELAP-2430	24"H for 30"W surfaces	\$140	\$215		
ELAP-1236	12"H for 36"W surfaces	\$110	\$160	ELAP-2436	24"H for 36"W surfaces	\$160	\$235		
ELAP-1242	12"H for 42"W surfaces	\$120	\$170	ELAP-2442	24"H for 42"W surfaces	\$190	\$265		
ELAP-1248	12"H for 48"W surfaces	\$140	\$190	ELAP-2448	24"H for 48"W surfaces	\$215	\$290		
ELAP-1260	12"H for 60"W surfaces	\$175	\$225	ELAP-2460	24"H for 60"W surfaces	\$275	\$350		
ELAP-1265	12"H for 66"W surfaces	\$200	\$250	ELAP-2465	24"H for 66"W surfaces	\$300	\$375		
ELAP-1271	12"H for 71"W surfaces	\$215	\$265	ELAP-2471	24"H for 71"W surfaces	\$330	\$405		
ELAP-1278	12"H for 78"W surfaces	\$240	\$290	ELAP-2478	24"H for 78"W surfaces	\$360	\$435		
ELAP-1284	12"H for 84"W surfaces	\$260	\$310	ELAP-2484	24"H for 84"W surfaces	\$390	\$465		
ELAP-Post-12"H		\$45		ELAP-Post 24"H		\$75			
ELAP-SP-12'H		\$20		ELAP-SP-24"H		\$30			

Perimeter may be custom upholstered in these 6 color options:

NEW Grade A Fabric for Perimeter Panels. Not Tackable.



15-04 Red



15-107 Powder



15-109



15-118 Lime







15-158 Green

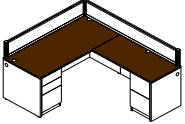
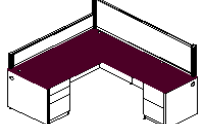
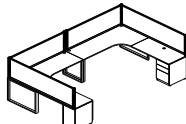
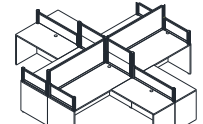
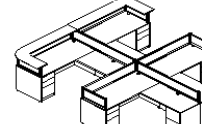

15-161 Blue

Perimeter

Frosted Acrylic or Fabric Divider Panel Systems

							
12" High	12 & 24" High	24" High	12", 24" and 2-12" stacked	12" with transaction tops			
12" High Panels		Acrylic	A-Fabric	24" High Panels		Acrylic	A-Fabric
ELAP-1224	12"H for 24"W surfaces	\$75	\$125	ELAP-2424	24"H for 24"W surfaces	\$100	\$175
ELAP-1230	12"H for 30"W surfaces	\$90	\$140	ELAP-2430	24"H for 30"W surfaces	\$140	\$215
ELAP-1236	12"H for 36"W surfaces	\$110	\$160	ELAP-2436	24"H for 36"W surfaces	\$160	\$235
ELAP-1242	12"H for 42"W surfaces	\$120	\$170	ELAP-2442	24"H for 42"W surfaces	\$190	\$265
ELAP-1248	12"H for 48"W surfaces	\$140	\$190	ELAP-2448	24"H for 48"W surfaces	\$215	\$290
ELAP-1260	12"H for 60"W surfaces	\$175	\$225	ELAP-2460	24"H for 60"W surfaces	\$275	\$350
ELAP-1265	12"H for 66"W surfaces	\$200	\$250	ELAP-2465	24"H for 66"W surfaces	\$300	\$375
ELAP-1271	12"H for 71"W surfaces	\$215	\$265	ELAP-2471	24"H for 71"W surfaces	\$330	\$405
ELAP-1278	12"H for 78"W surfaces	\$240	\$290	ELAP-2478	24"H for 78"W surfaces	\$360	\$435
ELAP-1284	12"H for 84"W surfaces	\$260	\$310	ELAP-2484	24"H for 84"W surfaces	\$390	\$465
ELAP-Post-12"H			\$45	ELAP-Post 24"H			\$75
ELAP-SP-12"H			\$20	ELAP-SP-24"H			\$30

Posts mount with 4 screws through the removable base into the desk top.

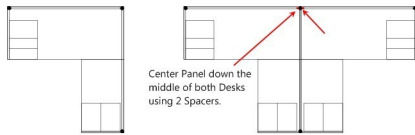

Center Panel down the middle of both Desks using 2 Spacers.

Perimeter can mount in the middle of two stations, and NOT take up more space from one employee at the expense of another employee. This is a unique benefit of Perimeter. To mount the center panel down the middle of two symmetrical stations: Use 2 Spacers where shown (Red Arrows)

Use 4 Spacers 4 at the intersection of 4 stations,

Further layout help is available, just ask.

Transaction Counters to mount on Perimeter Panels



Each is stocked in 5 colors: C, WT, DW, TS and MW. Cherry, White, Dark Walnut, Tiger Stripe (Gray) and Modern Walnut
1" Thick with 3 mil vinyl edge. Thicker top to match ELS Status is not currently available. 2 Panels in an L is required for Transaction Counters.

ELAP-TT-36	12" D Up to 84" wide	36" W 12"D	C, WT, DW, TS, and MW	\$45
ELAP-TT-42		42" W 12"D	C, WT, DW, TS, and MW	\$50
ELAP-TT-48		48" W 12"D	C, WT, DW, TS, and MW	\$60
ELAP-TT-59		59" W 12"D	C, WT, DW, TS, and MW	\$75
ELAP-TT-65		65" W 12"D	C, WT, DW, TS, and MW	\$80
ELAP-TT-71		71" W 12"D	C, WT, DW, TS, and MW	\$80
ELAP-TT-78		78" W 12"D	C, WT, DW, TS, and MW	\$110
ELAP-TT-84		84" W 12"D	C, WT, DW, TS, and MW	\$120

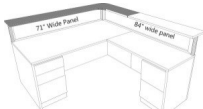
One Piece Corner Transaction Counters

ELAP-TT-65/30Corner ELAP-TT-71/30Corner ELAP-TT-71/35Corner		Price shown is for the shaded CORNER piece. Fits 65x30 Lair Worksurface or Desk Fits 71x30 Lair Worksurface or Desk Fits 71x35 Lair Worksurface or Desk	\$150 \$150 \$175
EL-FLAT BRACKET	EL101+EL145 shown 71"X84" El Flat required in typical above.	Corner is one piece and reversible Right or Left Stocked in 5 colors: C, WT, DW, TS and MW 2 Flat brackets and screws to attach transaction counters to each other end to end, like in this example.	\$8

Transaction mounting brackets below are required. Round is to join 2 transaction counters end to end.
Half round is for the end of a run of transaction counters.

ELAP Round ELAP Half Round EL Flat	  	Mounting bracket to attach Transaction counter. Mounting bracket to attach Transaction counter at end of run. 2 Flat brackets and 16 screws.	\$5 \$5 \$8
--	---	--	-------------------

NEW Grade A Fabric for Perimeter Panels. Not Tackable.		NEW Grade A Fabric
	15-04 Red 15-107 Powder 15-109 15-118 Lime 15-158 Green 15-161 Blue	

Chassis

CHASSIS is a new product with full laminate end panels and modesty panels. Grommet holes are included in the end panels of Chassis products to make wiring and wire management easier. Chassis is stocked in WHITE with 4 top choices: White, Dark Walnut, Tiger Stripe, and Modern Walnut. Lair tops and Chassis tops are the same tops and are interchangeable with Lair and Chassis. [L Shapes are our most popular station types.](#) We stock these in multiple sizes and multiple colors with many choices of Perimeter Divider Panel arrangements.



Modular

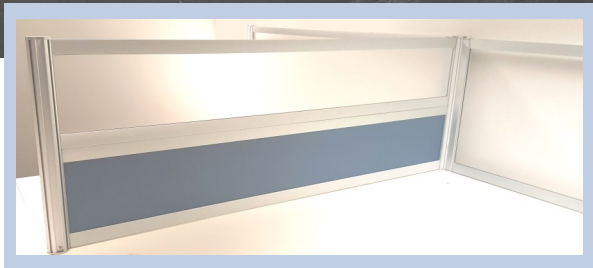

Perimeter Panels are 12" high and 24" high in frosted acrylic. Panels may also be custom fabric upholstered as shown.



Dark Walnut & White

\$1868 as shown



Tiger Stripe & White

\$2078 as shown

Chassis includes grommet holes in the end panels to accommodate ECA electrical 8 wire - 3 circuit Electrical UL Listed.



Mix and Match 4 Top colors: WT, DW, TS and MW with WHITE Lower chassis.
Chassis End Panels include Grommet holes to add electrical components.



All Lower Chassis are **WHITE** with choice of 4 top colors:

White/White - Dark Walnut/White - Tiger Stripe/White - Modern Walnut/White

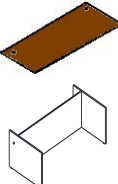
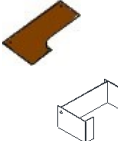
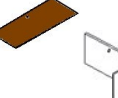
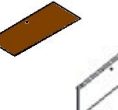
Chassis Tops and Lair Tops are the same product and are interchangeable.

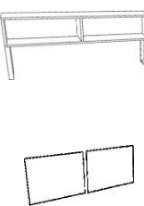
NEW Lair/Chassis Tops are now stocked in MW Modern Walnut

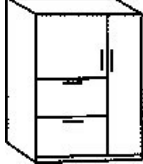
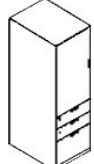
Model	Image	Description	List Price
Kit L-Chas + 71x30 Top Kit L-Chas + 66x30 Top Kit L-Chas + 71x24 Top Kit-L-Chas + 66x24 Top		71x30 Top only w 2 Grommets – WT, DW, TS, MW 66x30 Top only w 2 Grommets – WT, DW, TS, MW 71x24 Top only 2 Grommets – WT, DW, TS, MW 66X24 Top only w 2 Grommets – WT, DW, TS, MW The Lower Chassis is White and is included in the “Kit” Prices	\$340 Total \$290 Total \$265 Total \$265 Total
KIT L-Chas 71/36/24 + Top Left Left is Shown KIT L-Chas 71/36/24 + Top Right		71x36x24 Left or Right Top only for Corner Credenza WT, DW, TS, MW Specify Left or Right, Left is shown	\$405 Total \$405 Total
Kit-L-Chas 4824 Return + Top Kit-L-Chas 4224 Return + Top Kit-L-Chas 3624 Return + Top		48x24 Top only w 1 Grommet WT, DW, TS, MW 42x24 Top only w 1 Grommet WT, DW, TS, MW 36x24 Top only w NO Grommets WT, DW, TS, MW	\$200 Total \$190 Total \$175 Total
Kit-L-Chas 4824 Bridge + Top Kit-L-Chas 4224 Bridge + Top Kit-L-Chas 3624 Bridge + Top		48x24 Top only w 1 Grommet WT, DW, TS, MW 42x24 Top only w 1 Grommet WT, DW, TS, MW 36x24 Top only w NO Grommets WT, DW, TS, MW	\$165 Total \$170 Total \$145 Total
Kit-L-CHAS 1212-WT + Top (L-T3624)		White Full Height 2 Drawer Lateral File with Top. Now 24” D	\$600
Kit L-H71 + Mid Legs + Bar 62” overall height L-H71-Doors Kit L-H71 + Short Legs + Bar 54” Overall Height		71” W Hutch without Doors 62” High WT – White DW – Dark Walnut MW – Modern Walnut 4 Doors for 71” Hutch WT-DW-MW-TS 71” W Hutch without Doors 54” High WT – White DW – Dark Walnut MW – Modern Walnut	\$600 \$120 \$560

			
L-PSC54 54” High \$800 DW/W and W/W	L-PSC62 62 High \$700 DW/W and W/W	L-566 BBF Ped \$365 DW/W MW/W W/W TS/TS ELS Status Peds can also be used.	L-575-FF Ped \$365 DW/W MW/W W/W TS/TS ELS Status Peds can also be used.

All EL, L, and Status Pedestals may be used with Chassis Series.



Glass Divider Panel Kits & Transaction Tops

Mounting brackets are included in the KIT List Prices below, but you must specify which bracket is desired.

3 Brackets are included on the wider sizes: 58" 65" 70"

Modular

12" High

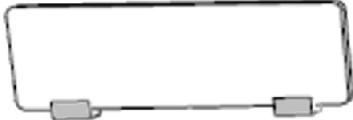
Kit Item #	Product	Description	List
KIT ELD-GF-1222		12"HX22"W Frosted Tempered Glass Divider Panel	\$110
KIT ELD-GF-1228		12"HX22"W Frosted Tempered Glass Divider Panel	\$120
KIT ELD-GF-1234		12"HX22"W Frosted Tempered Glass Divider Panel	\$135
KIT ELD-GF-1240		12"HX22"W Frosted Tempered Glass Divider Panel	\$150
KIT ELD-GF-1246		12"HX22"W Frosted Tempered Glass Divider Panel	\$160
KIT ELD-GF-1258		12"HX22"W Frosted Tempered Glass Divider Panel	\$210
KIT ELD-GF-1265		12"HX22"W Frosted Tempered Glass Divider Panel	\$225
KIT ELD-GF-1270		12"HX22"W Frosted Tempered Glass Divider Panel	\$245

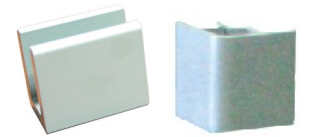

ELD-B12

ELD-B-Corner

\$20

\$20

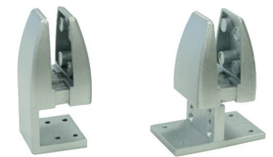

ELD-B-Edge

ELD-B-Center

\$20

\$20

18" High

KIT ELD-GF-1822		12"HX22"W Frosted Tempered Glass Divider Panel	\$120
KIT ELD-GF-1828		12"HX22"W Frosted Tempered Glass Divider Panel	\$135
KIT ELD-GF-1834		12"HX22"W Frosted Tempered Glass Divider Panel	\$150
KIT ELD-GF-1840		12"HX22"W Frosted Tempered Glass Divider Panel	\$165
KIT ELD-GF-1846		12"HX22"W Frosted Tempered Glass Divider Panel	\$180
KIT ELD-GF-1858		12"HX22"W Frosted Tempered Glass Divider Panel	\$240
KIT ELD-GF-1865		12"HX22"W Frosted Tempered Glass Divider Panel	\$255
KIT ELD-GF-1870		12"HX22"W Frosted Tempered Glass Divider Panel	\$270

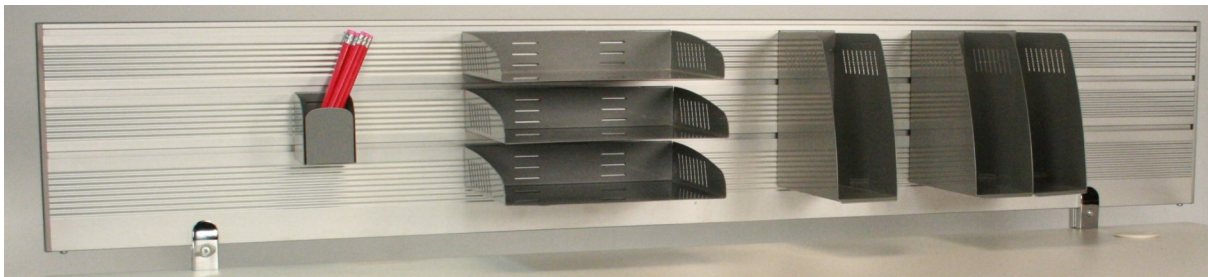

DT Slat Wall

Double Sided with 3 mounting rails on each side.

Slat Wall is Extruded Aluminum.

Paper Flow Tools are Painted Steel - Gray

Item	Description	List Price	
DT-Slat 47	47" Wide Slat Wall Double Sided	\$180	Requires the Mounting Brackets Shown Below
DT-Slat 59	59" Wide Slat Wall Double Sided	\$220	
DT-Slat 71	71" Wide Slat Wall Double Sided	\$315	



DT Center Bracket

\$20



DT Edge Bracket

\$20



DT Through Bracket

\$20

Item	Description	List Price	Item	Description	List Price
DT-09	Pencil Cup	\$15	DT-18	Binder Tray	\$45
DT-12	3-Letter Trays	\$90	DT-16	Binder Tray Double	\$50