

# EL

# Express Laminate

ELS & EL Desks

**Express Laminate** is a well built, commercial-duty product. All surfaces are thermo-fused plastic on environmentally friendly particleboard. All drawers have ball-bearing full suspensions and hanging file rails. All edges have 3 mil edging, including the edges of the box drawers. All products have leveling glides. The product is KD and assembles using steel pins, cam locks, dowels, L-brackets, and screws. Assembly is easy and, when complete, the product is very sturdy. **Assembly instructions are in each carton.**



**L-Unit** **\$1180**

L Unit- Our most popular set. 30x66 main desk with 47x24 return.

EL102/145/166/175 **\$1170**

EL102/145/107/107 **\$990** with 2 hanging B/F Peds

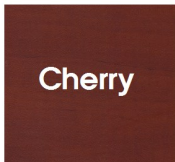

Cherry



Dark Walnut



Mahogany

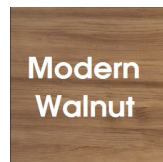

Modern Walnut



Optional Front Glass Trim for Reception Stations EL169 & ELS669. ELAP-3136 - **\$230.**



**Reception Desk with Perimeter Panels** **\$2055**

Reception station with glass perimeter panels. EL106-71x30 main desk with EL196-42x24 return plus two pedestals.



**Reception Station** **\$1465**

Reception station with 42" high transaction counter. EL169-71x36 main desk with EL180-42x24 return plus two pedestals.

# EL

# Express Laminate

ELS & EL Desks

## Executive-U with Bow Top

Executive-U unit with bow top desk, paperflow, storage cabinet, and hutch.

EL189/172/143/144/166/175/151/122

\$2730 as shown. \$2030 without storage cabinet.



Shown in Modern Walnut

## Executive U with Peninsula Island Desk

\$3195 as shown with hutch & personal storage tower.  
\$1990 without personal storage tower.



## Conference Tables

## Round & Racetrack

Available in racetrack shape and round. 10' & 12' are 2 piece tops.

### Round

EL 127, 42" \$260

EL 123, 48" \$320

### Racetrack

EL 135, 6' \$430 EL 137, 10' \$850

EL 136, 8' \$620 EL 138, 12' \$1150

## Bow Top Executive-U

\$3120

36/30 Bow Top main desk, 47x24 bridge, 71x24 credenza, 36W lateral file, 71W wall mounted overhead with optional glass doors, 36W overhead W optional glass doors.  
EL105FP/170/143/166/175/208/209/112/209-GD/208-GD

\$3120 as shown above. Overheads above are wall mounted.



# EL

# Express Laminate

ELS & EL Desks



### ← D-Top Conferencing Shape

Each modular piece includes wire management grommets. Drawer pulls are black on cherry and mahogany finish. Silver pulls on DW & MW finish. 71x36 D-Top, 47W curved cockpit bridge, 71x24 credenza, 71W hutch, 71Hx32W bookcase. EL147/172/143/175/144/156 \$1945 as shown \$1525 without bookcase



### Executive-U with Straight Front →

Executive-U unit with straight front desk and hutch with optional glass doors. EL101/170/143/166/175/144/144GD \$2085 as shown



### ← Executive-U

Shown in cherry finish with hutch and personal storage tower. Optional Drawer pulls are available, see page 9. EL189/172/143/166/175/144/122-17 = \$2030 EL207 Tall Storage Cabinet \$960. \$2990 as shown.



|       |       |        |       |             |       |       |       |
|-------|-------|--------|-------|-------------|-------|-------|-------|
| EL308 | \$365 | EL-156 | \$420 | EL153 Hutch | \$225 | EL155 | \$300 |
|-------|-------|--------|-------|-------------|-------|-------|-------|

Grade B \$420, Grade C \$ 440  
Mobile pedestal with upholstered seat.

Bookcase 71h x 32w x 14d  
with 1" thick sides and shelves.

35" Open Hutch. Sits on EL112 Lateral  
File or EL113 Storage Cabinet.

Bookcase 47h x 32w x 14d  
with 1" thick sides and shelves.

# Pedestals

Pedestals are stocked in a variety of colors and configurations to fit all of our desks, desking products, and systems - Status, Express Laminate, Lair, & Chassis.



White - W

Tiger Stripe - TS



Modern Walnut - MW

Two-Toned  
MW-W



Mahogany - M

Cherry - C

Pedestals are shown in the Express Laminate EL166 BBF.

BF, FF, & mobile also stocked.



Dark Walnut - DW

Two-Toned  
DW-W

Different configurations are stocked - *BBF, FF, BF, mobile, mobile with padded seats, BF hanging, 22" deep, 29" deep, and two-toned.*



**\*Optional**

**Drawer Pulls \$6 each**

\*DP840-96 Silver - Arc  
(Black not shown)

\*DP810-96 Silver - Bar

\*DP991-96 Silver - Rod

\*DP840-96 Black - Arc

All pedestals are finished on the back side and include adjustable glides, field changeable keys, and ball bearing progressive full-suspensions.

# EL

ELS & EL Desks

## Express Laminate

Prices shown are list prices.

All items are stocked in Cherry, Dark Walnut, and New Modern Walnut.

Most items are stocked in Mahogany.

Hanging file rails included for front-to-back and side-to-side.

Drawer bottoms are not suitable for heavy weight.



**EL114**      **\$680**

Combo Lateral File 31" wide.  
31x22x29

**EL112**      **\$580**

Two drawer lateral file.  
35w x 29h x 22d

**EL183**      **\$990**

3 drawer lateral file. 35w x 42h x 22d

**EL184**      **\$1400**

Four drawer lateral. 35w x 54h x 22d



**EL113 29"H**      **\$340**

29H x 35W x 22D, 1 Shelf  
Double door with lock & adjustable shelf.

**EL152 37"H**      **\$460**

37H x 35W x 22D  
2 Shelves

**EL161**      **\$500**

42H x 35W x 22D  
3 Shelves

**EL151 66"H**      **\$700**

66H x 35W x 22D, 5 Shelves



# EL



\*Requires Assembly\*

**Storage Credenza Assembly \$1290**

71Wx22D29H  
EL110 \$130 Top Only+  
EL112 Lateral file \$580 (x2)



**Storage Credenza Assembly \$1050**

71Wx22D29H  
EL110 \$130 Top Only+  
EL112 Lateral file \$580  
EL113 Storage cabinet \$340



**EL150 \$750**

71Wx22D29H, Storage Credenza  
1 adjustable shelf in each side



**EL122-17 \$120**

Paper Flow EL122-17 \$120  
17x17 Tackboard \$40 each, 3 shown above.  
4 Paper Flow and/or Tackboard will fit.



**ELL-Bench \$620**

48 X 18d X 20h storage bench  
Hinged top with storage and hanging file  
folder rails inside.  
Grade B \$825, Grade C \$900



**ELD153D+GD \$440 As Shown**

Small hutch 35Wx36H, sits on top of 2 drawer  
lateral or storage cabinet.  
2 adjustable shelves inside.  
EL153D Cabinet \$290 with Wood doors  
GD EL153 Optional Glass doors \$150



**EL208+GD \$395**

EL208 35W wall mounted + GD EL208  
optional glass doors.



**EL209+GD \$585**

71W wall mounted overhead  
EL209 + GD EL209 optional glass doors.  
Sized for 3 ring binder storage.



**EL209 \$325**

71W wall mounted overhead. Sized for 3 ring  
binder storage.

*Requires wall mounting by a professional installer. Mollies are not included.*



**EL207 \$960**

Storage tower and wardrobe cabinet.  
Includes closet bar. 24" W  
\*Comes fully assembled



**EL207+GD \$1205**

EL207 \$960 Personal storage tower  
+ GD EL207 \$245 Glass doors only  
\*Comes fully assembled



**EL507+GD \$660**

EL507 \$480 Wardrobe/Storage cabinet  
+ GD EL507 \$180 Glass door only.  
18" W

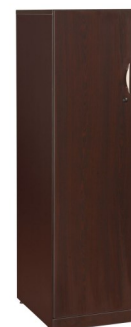







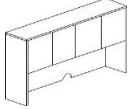

**EL507 \$480**

66Hx18Wx22D Storage and/or  
wardrobe cabinet. Includes closet bar.

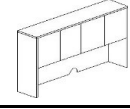
Express Laminate is stocked in 4 colors: C-Cherry, DW-Dark Walnut **NEW MW-Modern Walnut** and M-Mahogany, unless noted.

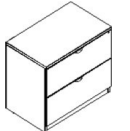
| Image                         | Item                        | Color                               | Description  | Price                       |
|-------------------------------|-----------------------------|-------------------------------------|--|-----------------------------|
|                               | EL189                       | All 4                               | Bow Top 71x36/42   | \$390                       |
|                               | EL101                       |                                     | 71x35 Desk ShL   | \$ 340                      |
|                               | EL106                       |                                     | 71x30 Desk ShL   | \$340                       |
|                               | EL102                       |                                     | 65x30 Desk ShL   | \$290                       |
|                               | EL103                       |                                     | 59x30 Desk ShL   | \$280                       |
|                               | EL104                       |                                     | 47x24 Desk ShL   | \$235                       |
|                               | EL121                       | 47x30 Desk ShL                      | \$270  |                             |
|                               | EL105FP                     | C, DW, MW                           | 36/30x71 Bow Top Full Ped style Desk ShL                           | \$440                       |
|                               | GM Mod 71                   |                                     | Glass Mod Panel for 71W Desks - EL105FP, EL106FP                   | \$145                       |
|                               | EL106FP                     | C, DW, MW                           | 71x30 Full Ped style Desk ShL                                      | \$400                       |
|                               | GM Mod 71                   |                                     | Glass Mod Panel for 71W Desks - EL105FP, EL106FP                   | \$145                       |
|                               | EL147                       | All 4                               | 71x35 D-Top Desk ShL   | \$350                       |
|                               | EL131                       | C & DW                              | 65x30 D-Top Desk ShL   | \$300                       |
|                               | EL377L-A                    | C & DW                              | Left Handed Cockpit P Top  | \$350                       |
|                               | EL377R-A                    |                                     | Right Handed Cockpit P Top   | \$350                       |
|                               | EL134                       | C, DW, MW                           | 42x42 Corner Desk ShL  | \$340                       |
|                               | EL111                       | All 4                               | 65x24 Credenza ShL   | \$265                       |
|                               | EL141                       | C & DW                              | 60x24 Credenza ShL   | \$260                       |
|                               | EL143                       | All 4                               | 71x24 Credenza ShL   | \$265                       |
|                               | EL182L                      | C, DW, MW                           | Corner Credenza 71x36x24x24 for L Return                           | \$390                       |
|                               | EL182R                      |                                     | Corner Credenza 71x36x24x24 for R Return                           | \$390                       |
|                               | EL170                       | All 4                               | 48x24 Bridge   | \$165                       |
|                               | EL172                       | C, DW, MW                           | Curved Corner 47W Bridge   | \$190                       |
|                               | EL197                       | All 4                               | 42x23 Bridge   | \$165                       |
|                               | EL193                       | C & DW                              | 36x24 Bridge   | \$145                       |
|                               | EL145                       | All 4                               | 47x24 Return   | \$190                       |
|                               | EL179                       | C, DW, MW                           | 30x24 Return   | \$135                       |
|                               | EL192                       | All 4                               | 36x24 Return   | \$170                       |
|                               | EL196                       | All 4                               | 42x23 Return   | \$190                       |
|                               |                             |                                     |  |                             |
| B/B/F Pedestal<br>EL166 \$345 | F/F Pedestal<br>EL175 \$345 | B/F Hanging Pedestal<br>EL107 \$255 | EL308 \$365    B-\$420 C-\$440<br>Mobile Pedestal with padded seat | EL148 \$440<br>B/B/F Mobile |
| All 4 Colors                  | All 4 Colors                | All 4 Colors                        | C, DW, MW, WT  | C, DW, MW                   |

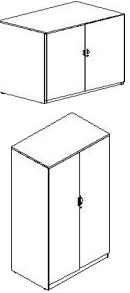
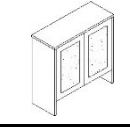
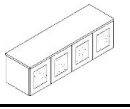
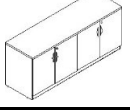
Please Add C, DW, MW or M as a suffix to the Model Number. **Some items are not stocked in Mahogany.**

|   |   |                             |  |                                  |
|---|---|-----------------------------|--|----------------------------------|
|    | EL144<br>GD EL144<br>EL118 BK or GY<br>TL36 | All 4                       | 71" Hutch W/Doors<br>Glass Doors for EL144 above<br>Black or Gray Tackboard for EL144 Hutch<br>Task Light mounts under Hutch | \$375<br>\$250<br>\$110<br>\$165 |
|    | EL122-17                                    | C, DW, MW                   | Paper Flow 17W X 12D X 21H fits 4 side by side in<br>71 Hutch  | \$120                            |
|    | EL140<br>EL117 BK or GY                     | All 4                       | 65" Hutch W/Doors<br>Black Tackboard For EL140 Hutch   | \$375<br>\$90                    |
|    | EL125<br>EL117                              | C & DW                      | 47" Hutch W/Doors<br>Tackboard for EL125 Hutch Black   | \$340<br>\$80                    |
|    | EL112<br>EL183<br>EL184                     | All 4<br>C, DW, MW<br>All 4 | Two Drawer Lateral File 35W 22D<br>Three Drawer Lateral File 35W 22D<br>Four Drawer Lateral File 35W 22D                     | \$580<br>\$990<br>\$1400         |
|    | EL114                                       | C, DW                       | 31" Combo Lateral File   | \$680                            |
|   | EL113                                       | All 4                       | 30H 2 Door Storage Cabinet 1 shelf   | \$340                            |
|   | EL152                                       | C, DW                       | 36H 2 Door Storage Cabinet 2 shelves   | \$460                            |
|   | EL161                                       | C, DW                       | 42H 2 Door Storage Cabinet 3 shelves   | \$500                            |
|   | EL151                                       | All 4                       | 66H 2 Door Storage Cabinet 5 shelves<br><br>35" W X 22 D   | \$700                            |
|  | EL153<br>EL153D<br>GD EL153 S653D           | All 4<br>C, DW, MW          | 35" W Open Hutch<br>Hutch with Wood Doors<br>Glass Doors for EL153D  | \$225<br>\$290<br>\$150          |
|   | EL208                                       | All 4                       | 36" Wall Mounted Hutch W/Doors   | \$260                            |
|   | GD EL208 S608                               |                             | EL208-GD Glass Doors for EL208 S608  | \$135                            |
|  | EL209                                       | C, DW, MW                   | 71" Wall Mounted Hutch W/Doors   | \$325                            |
|   | GD EL209 S209                               |                             | EL209-GD Glass Doors for EL209 S609  | \$260                            |
|  | EL150                                       | All 4                       | 71x22 4 Door Storage Credenza  | \$750                            |
|  | EL207<br>GD EL207 S657                      | C, DW, MW                   | Personal Storage Tower<br>EL207-GD Glass Door for EL207 S657   | \$960<br>\$245                   |

Tackboards are stocked in 2 colors: Black and Gray. They can be custom upholstered in 6 Stock Grade A fabrics below:

Add \$50 List per Tackboard.

Add \$140 for Culp Fabric and \$240 for Momentum fabrics.

Applies to EL and S- Status Tackboards.



15-04 Red



15-107 Powder



15-109



15-118 Lime











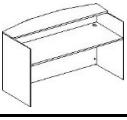
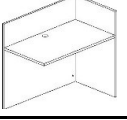

15-158 Green

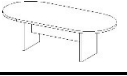
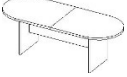
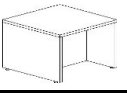

15-161 Blue

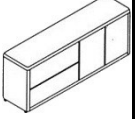
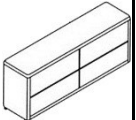

|   |                    |           |  |                  |
|---|--------------------|-----------|--|------------------|
|    | EL507<br>GD EL507  | C, DW, MW | Storage Cabinet<br>EL507GD Glass Door for EL507  | \$480<br>\$180   |
|    | EL155<br>EL156     | All 4     | Bookcase 48x32x14<br>Bookcase 71x32x14   | \$300<br>\$420   |
|    | EL169<br>ELAP-3136 | All 4     | Reception Desk ShL 42x71x36<br>Glass optional trim panel for EL169 & S669.<br>Includes 4 mounting posts. | \$490<br>\$230   |
|    | EL180              | All 4     | Reception Return 42x24   | \$285            |
|    | EL123<br>EL127     | All 4     | 47" Round Table<br>42" Round Table   | \$320<br>\$260   |
|    | EL135<br>EL136     | All 4     | 71x35 Racetrack Table<br>95x44 Racetrack Table   | \$400<br>\$620   |
|  | EL137<br>EL138     | C, DW, MW | 120x47 Racetrack Table<br>144x47 Racetrack Table   | \$850<br>\$1,150 |
|  | EL120              | C, DW, MW | 24x24x20H End Table  | \$175            |
|  | EL142              | C, DW, MW | Half Gable Leg   | \$75             |
|  | EL219              | C, DW     | Coffee Table   | \$270            |
|  | EL220              | C, DW     | End Table  | \$195            |
|  | EL110              | All 4     | 71x22 Top Only   | \$130            |
|  | EL110+EL112+EL113  | All 4     | 71W Top + 2 Drawer Lateral + Storage Cabinet<br>Requires Assembly  | \$1050           |
|  | EL110+ 2-EL112     | All 4     | 71W Top + 2 Lateral Files<br>Requires Assembly   | \$1290           |
|  | EZ CD              |           | Center Drawer, plastic with molded dividers  | \$80             |
|  | EL Key             |           | One replaceable lock cylinder and 2 Keys<br>Master Key or Change Key each                                | \$10<br>\$10     |

# Perimeter

**PERIMETER** has aluminum frames with **frosted acrylic inserts** or **custom upholstered fabric inserts**. Two heights are stocked at 12" and 24". Widths are 24" to 84". The product mounts to desk tops with Aluminum posts. Perimeter works with Lair, Chassis, Express Laminate, and Status Desks. Perimeter is shown below in its variety of lengths and heights.





Modular



EL Pinwheel with Multi-Height Panels



Chassis Multi-Height Panel Stations

| 12" High        |   | 12 & 24" High |          | 24" High        |   | 12", 24" and 2-12" stacked |          | 12" with transaction tops |  |
|-----------------|---|---------------|----------|-----------------|---|----------------------------|----------|---------------------------|--|
| 12" High Panels |   | Acrylic       | A-Fabric | 24" High Panels |   | Acrylic                    | A-Fabric |                           |  |
| ELAP-1224       | 12"H for 24"W surfaces  | <b>\$75</b>   | \$125    | ELAP-2424       | 24"H for 24"W surfaces  | <b>\$100</b>               | \$175    |                           |  |
| ELAP-1230       | 12"H for 30"W surfaces  | <b>\$90</b>   | \$140    | ELAP-2430       | 24"H for 30"W surfaces  | <b>\$140</b>               | \$215    |                           |  |
| ELAP-1236       | 12"H for 36"W surfaces  | <b>\$110</b>  | \$160    | ELAP-2436       | 24"H for 36"W surfaces  | <b>\$160</b>               | \$235    |                           |  |
| ELAP-1242       | 12"H for 42"W surfaces  | <b>\$120</b>  | \$170    | ELAP-2442       | 24"H for 42"W surfaces  | <b>\$190</b>               | \$265    |                           |  |
| ELAP-1248       | 12"H for 48"W surfaces  | <b>\$140</b>  | \$190    | ELAP-2448       | 24"H for 48"W surfaces  | <b>\$215</b>               | \$290    |                           |  |
| ELAP-1260       | 12"H for 60"W surfaces  | <b>\$175</b>  | \$225    | ELAP-2460       | 24"H for 60"W surfaces  | <b>\$275</b>               | \$350    |                           |  |
| ELAP-1265       | 12"H for 66"W surfaces  | <b>\$200</b>  | \$250    | ELAP-2465       | 24"H for 66"W surfaces  | <b>\$300</b>               | \$375    |                           |  |
| ELAP-1271       | 12"H for 71"W surfaces  | <b>\$215</b>  | \$265    | ELAP-2471       | 24"H for 71"W surfaces  | <b>\$330</b>               | \$405    |                           |  |
| ELAP-1278       | 12"H for 78"W surfaces  | <b>\$240</b>  | \$290    | ELAP-2478       | 24"H for 78"W surfaces  | <b>\$360</b>               | \$435    |                           |  |
| ELAP-1284       | 12"H for 84"W surfaces  | <b>\$260</b>  | \$310    | ELAP-2484       | 24"H for 84"W surfaces  | <b>\$390</b>               | \$465    |                           |  |
| ELAP-Post-12"H  |  | \$45          |          | ELAP-Post 24"H  |  | \$75                       |          |                           |  |
| ELAP-SP-12'H    |  | \$20          |          | ELAP-SP-24"H    |  | \$30                       |          |                           |  |

Perimeter may be custom upholstered in these 6 color options:

**NEW** Grade A Fabric for Perimeter Panels. Not Tackable.



15-04 Red



15-107 Powder



15-109



15-118 Lime







15-158 Green

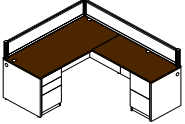
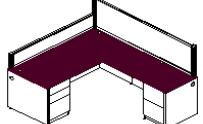
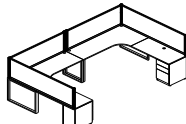
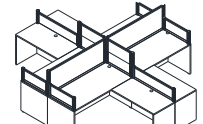
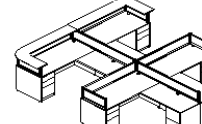

15-161 Blue

# Perimeter

## Frosted Acrylic or Fabric Divider Panel Systems

|   |   |   |  |   |   |         |          |
|---|---|---|--|---|---|---------|----------|
|  |  |  |  |  |   |         |          |
| 12" High  | 12 & 24" High   | 24" High  | 12", 24" and 2-12" stacked   | 12" with transaction tops   |   |         |          |
| 12" High Panels   |   | Acrylic   | A-Fabric   | 24" High Panels   |   | Acrylic | A-Fabric |
| ELAP-1224   | 12"H for 24"W surfaces  | \$75  | \$125  | ELAP-2424   | 24"H for 24"W surfaces  | \$100   | \$175    |
| ELAP-1230   | 12"H for 30"W surfaces  | \$90  | \$140  | ELAP-2430   | 24"H for 30"W surfaces  | \$140   | \$215    |
| ELAP-1236   | 12"H for 36"W surfaces  | \$110   | \$160  | ELAP-2436   | 24"H for 36"W surfaces  | \$160   | \$235    |
| ELAP-1242   | 12"H for 42"W surfaces  | \$120   | \$170  | ELAP-2442   | 24"H for 42"W surfaces  | \$190   | \$265    |
| ELAP-1248   | 12"H for 48"W surfaces  | \$140   | \$190  | ELAP-2448   | 24"H for 48"W surfaces  | \$215   | \$290    |
| ELAP-1260   | 12"H for 60"W surfaces  | \$175   | \$225  | ELAP-2460   | 24"H for 60"W surfaces  | \$275   | \$350    |
| ELAP-1265   | 12"H for 66"W surfaces  | \$200   | \$250  | ELAP-2465   | 24"H for 66"W surfaces  | \$300   | \$375    |
| ELAP-1271   | 12"H for 71"W surfaces  | \$215   | \$265  | ELAP-2471   | 24"H for 71"W surfaces  | \$330   | \$405    |
| ELAP-1278   | 12"H for 78"W surfaces  | \$240   | \$290  | ELAP-2478   | 24"H for 78"W surfaces  | \$360   | \$435    |
| ELAP-1284   | 12"H for 84"W surfaces  | \$260   | \$310  | ELAP-2484   | 24"H for 84"W surfaces  | \$390   | \$465    |
| ELAP-Post-12"H  |  |   | \$45   | ELAP-Post 24"H  |  |         | \$75     |
| ELAP-SP-12"H  |  |   | \$20   | ELAP-SP-24"H  |  |         | \$30     |

Posts mount with 4 screws through the removable base into the desk top.

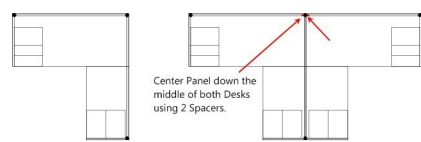

Perimeter can mount in the middle of two stations, and NOT take up more space from one employee at the expense of another employee. This is a unique benefit of Perimeter. To mount the center panel down the middle of two symmetrical stations: Use 2 Spacers where shown (Red Arrows)  
Use 4 Spacers 4 at the intersection of 4 stations,  
**Further layout help is available, just ask.**

**Transaction Counters to mount on Perimeter Panels**  
Each is stocked in 5 colors: C, WT, DW, TS and MW. Cherry, White, Dark Walnut, Tiger Stripe (Gray) and Modern Walnut  
1" Thick with 3 mil vinyl edge. Thicker top to match ELS Status is not currently available. 2 Panels in an L is required for Transaction Counters.

|            |                      |            |                       |       |
|------------|----------------------|------------|-----------------------|-------|
| ELAP-TT-36 | 12" D Up to 84" wide | 36" W 12"D | C, WT, DW, TS, and MW | \$45  |
| ELAP-TT-42 |                      | 42" W 12"D | C, WT, DW, TS, and MW | \$50  |
| ELAP-TT-48 |                      | 48" W 12"D | C, WT, DW, TS, and MW | \$60  |
| ELAP-TT-59 |                      | 59" W 12"D | C, WT, DW, TS, and MW | \$75  |
| ELAP-TT-65 |                      | 65" W 12"D | C, WT, DW, TS, and MW | \$80  |
| ELAP-TT-71 |                      | 71" W 12"D | C, WT, DW, TS, and MW | \$80  |
| ELAP-TT-78 |                      | 78" W 12"D | C, WT, DW, TS, and MW | \$110 |
| ELAP-TT-84 |                      | 84" W 12"D | C, WT, DW, TS, and MW | \$120 |



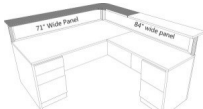



**One Piece Corner Transaction Counters**

|   |   |  |                         |
|---|---|--|-------------------------|
| ELAP-TT-65/30Corner<br>ELAP-TT-71/30Corner<br>ELAP-TT-71/35Corner |  | Price shown is for the shaded CORNER piece.<br>Fits 65x30 Lair Worksurface or Desk<br>Fits 71x30 Lair Worksurface or Desk<br>Fits 71x35 Lair Worksurface or Desk   | \$150<br>\$150<br>\$175 |
| EL-FLAT BRACKET   | EL101+EL145 shown<br>71"X84"<br><b>El Flat required in typical above.</b>           | Corner is one piece and reversible Right or Left<br>Stocked in 5 colors: C, WT, DW, TS and MW<br>2 Flat brackets and screws to attach transaction counters to each other end to end, like in this example. | \$8                     |

**Transaction mounting brackets below are required.** Round is to join 2 transaction counters end to end.  
Half round is for the end of a run of transaction counters.

|  |   |  |                   |
|--|---|--|-------------------|
| ELAP Round<br>ELAP Half Round<br>EL Flat |  | Mounting bracket to attach Transaction counter.<br>Mounting bracket to attach Transaction counter at end of run.<br>2 Flat brackets and 16 screws. | \$5<br>\$5<br>\$8 |
|--|---|--|-------------------|

**NEW** Grade A Fabric for Perimeter Panels. Not Tackable.

**NEW** Grade A Fabric





## Glass Divider Panel Kits & Transaction Tops

Mounting brackets are included in the KIT List Prices below, but you must specify which bracket is desired.

3 Brackets are included on the wider sizes: 58" 65" 70"

Modular

12" High

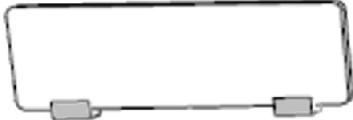
| Kit Item #      | Product   | Description                                    | List  |
|-----------------|---|--|-------|
| KIT ELD-GF-1222 |   | 12"HX22"W Frosted Tempered Glass Divider Panel | \$110 |
| KIT ELD-GF-1228 |   | 12"HX22"W Frosted Tempered Glass Divider Panel | \$120 |
| KIT ELD-GF-1234 |   | 12"HX22"W Frosted Tempered Glass Divider Panel | \$135 |
| KIT ELD-GF-1240 |  | 12"HX22"W Frosted Tempered Glass Divider Panel | \$150 |
| KIT ELD-GF-1246 |   | 12"HX22"W Frosted Tempered Glass Divider Panel | \$160 |
| KIT ELD-GF-1258 |   | 12"HX22"W Frosted Tempered Glass Divider Panel | \$210 |
| KIT ELD-GF-1265 |   | 12"HX22"W Frosted Tempered Glass Divider Panel | \$225 |
| KIT ELD-GF-1270 |   | 12"HX22"W Frosted Tempered Glass Divider Panel | \$245 |

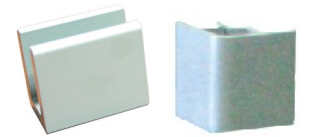

ELD-B12

ELD-B-Corner

\$20

\$20

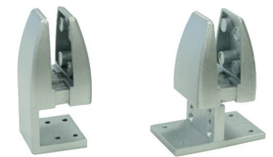

ELD-B-Edge

ELD-B-Center

\$20

\$20

18" High

|                 |  |  |       |
|-----------------|--|--|-------|
| KIT ELD-GF-1822 |  | 12"HX22"W Frosted Tempered Glass Divider Panel | \$120 |
| KIT ELD-GF-1828 |  | 12"HX22"W Frosted Tempered Glass Divider Panel | \$135 |
| KIT ELD-GF-1834 |  | 12"HX22"W Frosted Tempered Glass Divider Panel | \$150 |
| KIT ELD-GF-1840 |  | 12"HX22"W Frosted Tempered Glass Divider Panel | \$165 |
| KIT ELD-GF-1846 |  | 12"HX22"W Frosted Tempered Glass Divider Panel | \$180 |
| KIT ELD-GF-1858 |  | 12"HX22"W Frosted Tempered Glass Divider Panel | \$240 |
| KIT ELD-GF-1865 |  | 12"HX22"W Frosted Tempered Glass Divider Panel | \$255 |
| KIT ELD-GF-1870 |  | 12"HX22"W Frosted Tempered Glass Divider Panel | \$270 |



## DT Slat Wall

Double Sided with 3 mounting rails on each side.

Slat Wall is Extruded Aluminum.

Paper Flow Tools are Painted Steel - Gray

| Item       | Description                     | List Price |  |
|------------|---------------------------------|------------|--|
| DT-Slat 47 | 47" Wide Slat Wall Double Sided | \$180      | Requires the<br>Mounting Brackets<br><br>Shown Below |
| DT-Slat 59 | 59" Wide Slat Wall Double Sided | \$220      |  |
| DT-Slat 71 | 71" Wide Slat Wall Double Sided | \$315      |  |



DT Center Bracket

\$20



DT Edge Bracket

\$20



DT Through Bracket

\$20

| Item  | Description    | List Price | Item  | Description        | List Price |
|-------|----------------|------------|-------|--------------------|------------|
| DT-09 | Pencil Cup     | \$15       | DT-18 | Binder Tray        | \$45       |
| DT-12 | 3-Letter Trays | \$90       | DT-16 | Binder Tray Double | \$50       |